

FreeRider[®]

ATTENTION
READ ALL PARTS IN THIS
MANUAL BEFORE OPERATING
YOUR SCOOTER



FR510DXs2b

USER'S INSTRUCTION MANUAL



SAFETY GUIDELINES

WARNING! An authorised dealer or certified technician must perform the initial setup of this scooter and must perform all of the procedures in this manual.

The symbols below are used throughout this user's instruction manual and on the scooter to identify warnings and important information. It is very important for you to read them and understand them completely before using the scooter.



WARNING! Indicates a potentially hazardous condition/situation. Failure to follow designated procedures can cause either personal injury, component damage, or malfunction. On the product, this icon is represented as a red triangle with red exclamation mark.



CAUTION! Indicates situations where extra caution should be taken. These actions should not be performed at any time or in any circumstances. These actions can cause personal injury and/or equipment damage. On the product, this icon is represented as a triangle with red border.

Please fill out the following information for quick reference:

Freerider dealer: _____
Address: _____
Phone Number: _____
Purchase Date: _____ Serial Number: _____

NOTE: This user's instruction manual is compiled from the latest specifications and product information available at the time of publication. We reserve the right to make changes as they become necessary. Any changes to our products may cause slight variations between the illustrations and explanations in this manual and the product you have purchased. The latest/current version of this manual is available on our website.



FOREWORD

Please read and follow all instructions in this User's Instruction Manual before attempting to operate your scooter for the first time. If there is anything in this manual that you do not understand, or if you require additional assistance for setting it up, contact your nearest Freerider authorised dealer.

Using your product safely depends upon your diligence in following the warnings, cautions and instructions in this manual.

A full technical specification can be found at the rear of this manual.

Using your scooter safely also depends upon your good judgment and common sense, as well as that of your dealer, caregiver or health professional.



CONTENTS

Introduction	3
Purpose of your scooter	4
Rules for safe use	5
Getting to know your scooter	8
Comfort Adjustments	9
Operating your scooter	13
Freewheeling your scooter	18
Safety instructions & warning	19
Safety warning & instruction labels	21
Learning to get about	22
Care & Maintenance	24
Batteries & battery charging	26
Basic fault finding	27
Technical specification	30
Classification	33
Optional accessories	34
Guarantee terms	35
Service history	36



INTRODUCTION

Congratulations on purchase of your scooter.

Please read this User Instruction Manual carefully before you attempt to operate scooter. Your User's Instruction Manual will assist you in order to most from your scooter.

The scooter provides transportation for a disabled person. It can be used in a variety of indoor and outdoor settings.

This manual contains important information regarding the safe operation and maintenance of your scooter. Before beginning to use your scooter, make sure you completely read and understand all instructions thoroughly. If you have any queries concerning operation or maintenance, consult your authorised Freerider dealer.

Please keep in mind that the operator of the scooter is responsible for hazards occurring to other people or their property.

Your scooter has numerous features not found on other power scooters. With proper care and maintenance, you will enjoy many years of dependable service. Your scooter needs to receive maintenance at regular intervals and should be inspected frequently for proper mechanical operation. Methods of detecting improper operation and making minor adjustments are included in manual.

Follow all recommendations to obtain trouble free, safe and enjoyable operation of your scooter.

Please remember that when it comes to service and repairs, your authorised dealer knows your scooter best.



PURPOSE OF YOUR SCOOTER

Your scooter provides transportation for a disabled person. It can be used in a variety of indoor and outdoor settings.

The intended user should possess some degree of ability with the use of arms and hands, reasonable balance and good eyesight, and a degree of spatial awareness.

The user should have received training in the use of the scooter, preferably in their normal environment.

Your scooter should not be used in heavy rain, snow, ice, on loose slippery surfaces and slopes or on wet grass etc., which could become a danger to the rider, or other road users.

Do not drive your scooter if you are under the influence of alcohol, drugs or medication that may affect your ability. If you are in doubt, consult your doctor.



FR510DXs2b



RULES FOR SAFE USE

These symbols below are used in this User's Instruction manual to identify warnings and cautions. It is very important for you to read and understand them before operating your scooter.



Warning: Failure to note the warnings in this user's manual may result in personal injury.

Your scooter is a powerful machine. Please read all of the instructions in this manual before operating your scooter. Follow notes carefully to ensure safety at all times.

Always make certain your machine is fully charged and in full working order before starting your journey.

Weight Limitations: Your scooter is rated for a maximum weight capacity of 25st/160kgs.

1. **Do not** ride your scooter without reading this instruction manual. Also read all of the safety instructions and warnings at the start of this manual.
2. Only drive your scooter if your health condition will allow you to be safe.
3. **Do not** exceed the maximum safe gradient outlined for your vehicle.
4. **Do not** carry passengers or exceed the maximum carrying weight.
5. **Do not** reverse your scooter onto uneven inclines or surfaces. Be cautious when traversing slopes.
6. **Do not** drive your scooter in a confined space unless the speed adjustment dial is set low.
7. **Do not** turn suddenly at full speed, especially on uneven or sloping ground.
8. **Do not** drive your scooter where you cannot safely or legally walk.
9. **Do not** drive your scooter unless the seat is locked into the driving position.
10. **Do not** drive your scooter over deep soft terrain (e.g. soft earth, deep grass, loose gravel, snow).
11. **Do not** drive when under the influence of alcohol or certain drugs which may impair your safety.

12. **Do not** climb or descend curbs that exceed the maximum dimension detailed under technical specification of this manual. **Do not** turn when negotiating curbs.

13. Always approach obstacles at low speed.

14. Always approach obstacles straight.

15. Always keep your feet on the vehicle when driving.

16. Always proceed carefully while riding, especially as you approach the downgrade of a ramp.

17. Always reduce speed when descending inclines.

18. Always avoid uneven surfaces.

19. Always consult your doctor or a therapist if in doubt about your ability to operate a scooter.

20. Transport - **Do not** sit on your scooter while it is in a moving vehicle. Always strap down your scooter.

21. The batteries fitted to your scooter are maintenance free and **do not** require topping up with distilled water.

22. **Do not** drive your scooter through water or clean with a high pressure hose.

23. **Do not** drive your scooter through sea sand or sea water, this is very corrosive.

Always wash salt splashing from the metal parts of your scooter with hot soapy water as soon as possible.

24. **Do not** drive on motorways, highways (i.e. those with a speed limit of over 50mph), cycle lanes or in bus lanes.

25. Always switch your lights on at night or in poor visibility. Wear reflective clothing.

Please remember you are a motorised pedestrian and must observe all rules and regulations of other pedestrians wherever possible. Your scooter has been designed for use on most roads; drive with due care and attention. Read the "**Safety instructions and warnings**" section of this manual.

ELECTROMAGNETIC AND RADIO FREQUENCY INTERFERENCE (EMI/RFI)

Electromagnetic and Radio Frequency Interference can come from sources such as cellular phones, mobile two-way radios, radio stations, TV stations, amateur radio (HAM) transmitters, wireless computer links, microwave signals, paging transmitters, and medium-range mobile transceivers used by emergency vehicles.

In some cases, these waves can cause unintended movement or damage to the control system.

Every electrically-powered mobility scooter has an immunity (or resistance) to EMI. The higher the immunity level, the greater the protection against EMI. This product has been tested and has passed at an immunity level of 20 V/M.



Warning: Be aware that cell phones, two-way radios, laptops, and other types of radio transmitters may cause unintended movement of your electrically-powered mobility scooter due to EMI.

Exercise caution when using any of these items while operating your mobility vehicle and avoid coming into close proximity of radio and TV stations.



Warning: The addition of accessories or components to the electrically-powered mobility scooter can increase the susceptibility of the vehicle to EMI.



Warning: The electrically-powered mobility scooter itself can disturb the performance of other electrical devices located nearby, such as alarm systems.

Please have a safe journey!



GETTING TO KNOW YOUR SCOOTER



1. Steering handlebars
2. Wing mirror
3. Console
4. Charging socket
5. Basket
6. Front light
7. Direction indicator lights
8. Front and Rear bumper
9. Amber side reflectors
10. Floor mat
11. Pneumatic wheels with black tyres
12. Rear lights and indicators
13. Adjustable angle seat with backrest

FR510DXs2b

Your scooter is delivered fully assembled, fitting the two batteries and the seat assemblies together with some minor adjustments are detailed on the following pages, under "**Operating your Scooter**". A full technical specification for your scooter can be found at the rear of this manual.

A great deal of thought has gone into the design of your four wheeled scooter which will allow you to negotiate obstacles found in confined shopping areas. Also, the four wheels will give you added stability on uneven surface. A contoured seat giving you day-long comfort. A fully proportional speed-controller with a speed restriction facility allows you a smooth, safe jerk-free ride.



Caution:

Do not switch "off" the on/off power key when you are moving; this will automatically apply the motor parking brake suddenly and could place you in a dangerous situation. Your scooter is fitted with anti-tipping wheels.

Do not remove these anti-tipping wheels; they are an important part of the scooter design provided specifically for your safety.



COMFORT ADJUSTMENTS

Before setting out on your scooter, you need to make sure that your seat is in the correct driving position. The seat has three basic adjustments to assist your comfort.

1. Mirror Assembly:



2. Seat Lock Lever:



This allows the seat to swivel through 360 degrees: Pull up fully to release the seat allowing rotation. Release lever to lock the seat into the desired position.



Caution: The seat locking lever must be locked in place and be lifted up fully when rotating the seat, failure to observe this may result in unnecessary wear of the seat post.

Removing seat from scooter:

The seat mounting post is designed with a special safety lifting point, this will prevent the seat from inadvertently coming off. It can only be removed by turning the 90 degrees from the forward driving position.



3. Armrest Width Adjustment:

On each side at the rear of the seat you will find a large black knob. By simply loosening this knob you are able to slide the armrests in or out to whatever width you desire. Re-tighten the knobs fully.



Warning: Do not drive your scooter with the arms removed or in the raised position.



4. Armrest Angle Adjustment:

The armrest angle can be adjusted individually to suit your needs. To make adjustments to the armrest angle you will need two 13mm wrenches (not provided). Lift the arm upwards, you will note the adjusting bolt. First loosen the locking nut, rotate the bolt in or out until the required angle is found, lower the arm and check the angle for comfort; re-adjust as necessary. Finally tighten the locking nut.

5. Seat Height Adjustment:

You may need to alter the seat height setting at a later date, please follow these instructions.

- (1) Remove your seat from the scooter by lifting the seat.
- (2) With the aid of a 16mm wrench (not supplied) loosen the 10mm seat clamp fixing bolt from side of seat post. Remove the 10mm fixing bolt and reposition the bolt into one of the four preferred location holes of the seat mounting tube.
- (3) Re-tighten the 10mm fixing screw.
- (4) Refit the seat onto your scooter.



6. Seat Slide:

Located on the right front side of the seat. The lever allows you to adjust your seat forwards and backwards when sitting on the seat. Simply pull up the lever and move in the desired position backward by pushing or forward by hitching. As soon as the lever is released, the seat will lock into the new position.



Caution: Check the seat has fully locked by hitching backwards and forwards.



7. Handlebar Adjustment:

The handlebar of your scooter is designed to allow you to position it in a comfortable driving position. It can be locked into numerous positions or unlocked to move freely for transportation. The handlebar lock is operated by a black lever positioned on the right hand side of the handlebar.



To release the handlebar from a locked position pull the black lever upwards, the handlebar will now move freely, but under mild tension.

8. Backrest Height Adjustment:

The upper cushion of your backrest can be adjusted for height, giving you more back support if you are tall, by operating the small latch at the base of the left hand round support bar. Lift the cushion up or push down for the most comfortable position. The headrest will also lift out for convenience.

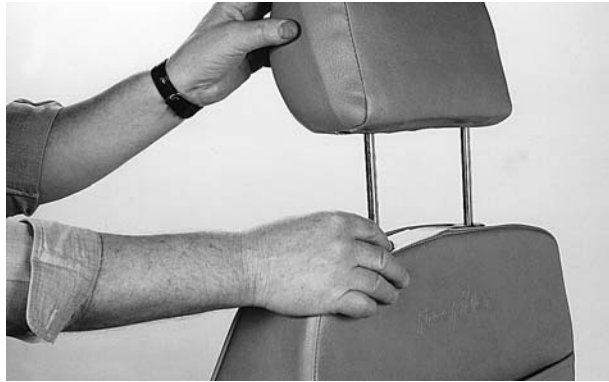

9. Lap Safety Belt:

Your scooter seat is fitted with a safety belt to prevent you from slipping forwards under braking conditions or when going down a slope or over obstacles, always use it-even for short journeys.

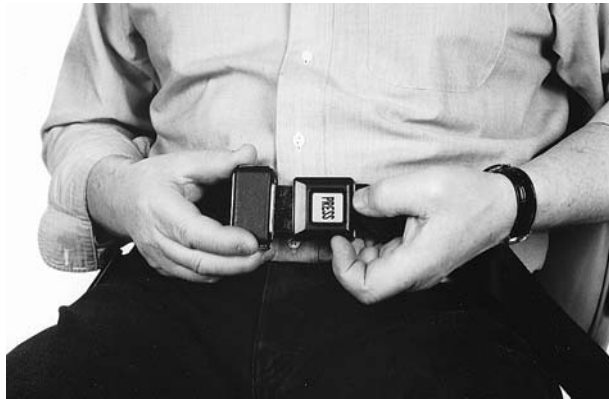

The lap belt can be adjusted on one side to fit comfortably around your waist. To fit simply connect

the two buckles together until a distinct "**click**" is heard. To remove simply press' the red buckle and the two belts will separate.



Caution: Care should be taken when the belt is not in use, it should be connected together and placed in the center of the seat cushion. Failure to observe this notice could lead to the two buckles falling onto and damaging the bodywork, catching a person or foreign body.



OPERATING YOUR SCOOTER

1. Control Features:

Your controls are located on the handlebar console:

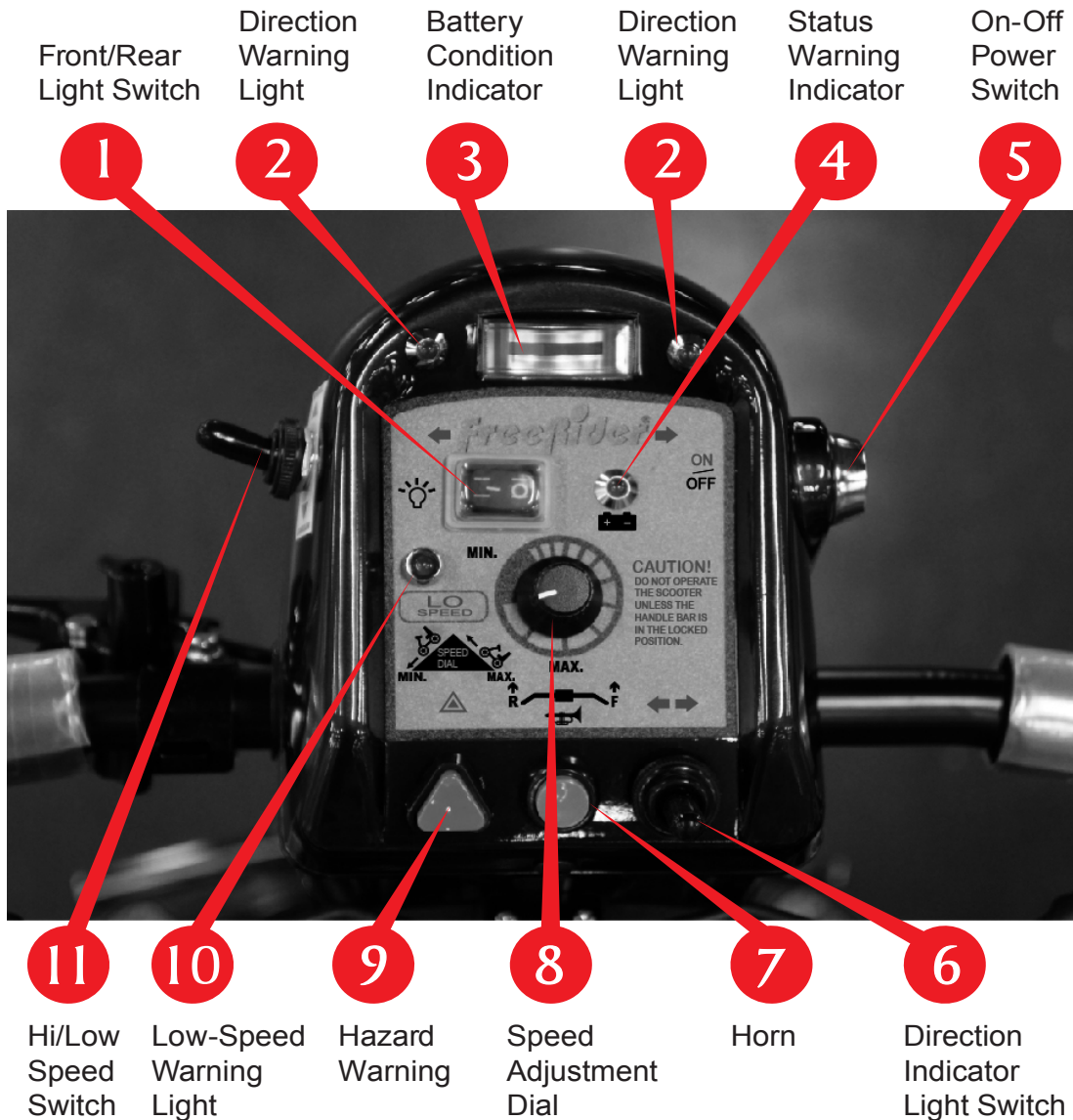

(1) Front/Rear Light Switch:

This rocker type switch controls the function of the front and rear lights. Simply push down on the left side for 'on' and the right side for "off".

(2) Direction Warning Light:

This green light will illuminate when the direction indicator switch is activated to the right for a right turn and to the left for a left turn. The light will also flash at a higher rate than normal to indicate a bulb failure in one of the front or rear direction lights.

(3) Battery Condition Indicator:

Located at the top left of your console. When your scooter is switched on, the needles on the gauge will move across the scale from the left 'red' sector towards the "green" sector, indicating the state of charge in your batteries. As the power is used up in your batteries the needle will move towards the red sector indicating the state of charge at that precise time. When the needle is fully over to the right (green sector), the batteries are fully charged. When the needle falls towards the red sector your batteries are losing power, but you will still have power to spare. When the needle falls into the red sector your batteries are low in power and need to be re-charged, although you will still have approximately 30 minutes normal flat pavement driving reserve. It is not recommended to use this power regularly as it will shorten battery life. It is wise to re-charge your batteries when the needle enters the red zone (see Batteries and Battery Charging section of this manual).

Note: When driving up steep slopes or similar obstacles your scooter's motor will be working hard, the battery gauge may move towards the red sector, it will recover towards the green sector once the load on your motor is reduced, this does not indicate low batteries.

(4) Status Warning Indicator:

Status warning indicator Light: When you turn your scooter on, the green light on your console will illuminate at a constant rate. The status light is connected to a very sophisticated diagnostic system which can identify faults which could occur on the main speed control system or some other part of your scooter's electronic drive system. For instance if your batteries run low in power, the status light will flash slowly at one flash a second; this indicates your batteries need recharging. If you notice the status light flashing at two flashes per second, you are being notified that the battery voltage is too low and you must stop using your scooter at the earliest opportunity. Your status light has nine similar flashing diagnostic signals, reference to these diagnostic codes is found under 'Fault Finding' at the rear of this manual.

(5) On-Off Power Switch:

Located on the right side of your control console. Insert the key and turn clockwise. This controls the power to your speed control system. You will note that after half a second the battery condition gauge will illuminate with a solid light. Your scooter is now ready to drive. To switch off your scooter turn the key anti-clockwise. Remove the key when your vehicle is left unattended.



Caution: Do not switch to "off" when your scooter is moving. Failure to observe this warning will result in the motor brake being applied suddenly and placing you in a dangerous situation.

You should only switch "off" when in motion in the case of an emergency. Continual use in this mode may cause undue stress to the drive system and damage the main electronic speed control unit. Be extremely cautious on slopes. Sit upright in your seat or your machine could become less stable.

Sleep Time: When you rest your scooter with the electronics switched "on" you are using valuable battery power. Your scooter will automatically go into a sleep mode to preserve battery energy after approximately 15 minutes. To start your scooter again simply switch the key to 'off' and back to "on" again, your scooter is now ready to go.

(6) Direction Indicator Light Switch:

Located at the bottom right of your console, the direction indicator lights for right and left manoeuvres are controlled by this switch. When making a turning manoeuvre on the road the appropriate switch direction should be made. Simply, when turning right "flick" the switch to the right, you will note a warning "**beeper**" is audible and the appropriate direction warning light will flash. To cancel the direction indicator return the switch to the centre position. The left direction indicators are activated by "**flicking**" the switch to the left.



Caution: Please note the direction indicators are not self-cancelling.



Warning: Please be aware to test the function of your direction lights before each journey. Failure to observe this warning could put you and other road users into a dangerous situation. If in the event a direction indicator bulb fails, you will note the direction warning light on your console flashing quicker than normal, in this situation the appropriate bulb should be substituted.

(7) Horn Button:

(Yellow) Positioned in the bottom centre of your console, press to sound a warning to other road users.

(8) Speed Adjustment Dial:

This allows you to pre-select you desired top speed. The dial is proportional to speed and can be set anywhere between 'min' and "max" increments.

Turn the dial knob anti-clockwise to minimum for a very gentle operation, and clockwise towards maximum to increase your speed.

(9) Hazard Warning:

Positioned to the bottom left of your console, when pressed this red triangular button activates all of the amber flashing direction lights to warn other road users that you are stationary or in distress. This function should only be used in emergencies. You will note that both green direction lights at the top of your console are flashing to warn you the hazard system is in operation. To cancel the hazard warning simply press and release the red triangular button.

NOTE: When attempting to climb obstacles, you will need to set the speed dial to a high setting. Remember the higher position you set your speed dial to, the faster your scooter will travel.



Caution: The speed adjustment dial (1) works in conjunction with the Hi/Lo speed switch (2), if both are set to their lowest settings there may not be sufficient power delivered to the motor to drive your scooter, in this case turn the speed dial up to a higher setting.

(10) 4m.p.h. Low Speed Warning Light:

This red light will illuminate when the Hi/Low speed switch is engaged in the slow speed position, see also point No.11 below - Hi/Low speed switch.

(11) Hi/Low speed Switch:

Located on the left side of your console this switch controls the maximum high (Hi) and low (Lo) speed range for your scooter. When riding on the pavement or in shopping areas the low 4 mph speed range must be engaged, this is a legal requirement and must be adhered to at all times. When the low speed range is chosen a "red" warning light will illuminate. The Hi/Lo speed range switch can be operated while the Scooter is in motion.

Please note the Hi/Lo speed switch works in conjunction with the speed adjustment dial and the forward/reverse speed lever; the speed dial must be set to it's highest setting for maximum speed in both Hi and Low speed settings.

2.Forward-Reverse speed and braking lever

Located under the handlebar grips. Your speed and braking in forward and reverse motion is controlled here. The right lever moves your scooter in a forwards direction and also controls the rate of speed by the proportional amount of pressure applied. The left lever moves the scooter in a reverse direction and controls the rate of speed by the pressure applied.



The lever when released will automatically return itself to the neutral braking position, and you will slow down and gently stop. The rate at which you brake is also proportional to the movement of the control lever, the quicker you return it to the centre position the harder you will brake. Your distributor can modify your scooter if you require so that the left hand lever will give you forward speed direction and the right hand lever will give you reverse speed direction.



Warning: Do not attempt to operate the right and left lever simultaneously, failure to observe this warning may distort the lever system and could put you at risk. It should also be noted that reverse speed is set at half of full speed, this is a safety precaution, always make certain the Hi/Lo speed switch and the "min and max" speed selection dial are set high enough to give you adequate power for your reverse manoeuvre.



Warning: If you are not an accomplished outdoors powered vehicle driver, we strongly recommend that you seek advice from your local "road safety officer" who may be able to advise you of any training schemes that are available in your locality, your local Freerider dealer may also help you in finding training in road craft skills.

We strongly recommend that you first practice in an open, safe area, free from traffic, preferably with a companion who can assist you. Please remember as a road user you are required by law to drive your scooter with due care and regard to other road users and pedestrians. Although you do not by law require a driving license, M.O.T. test or insurance, we strongly recommend that you insure yourself and your scooter against any risk that could occur, your Freerider Dealer will advise you of insurance companies who specialise in this field or you could seek advice from your own insurance company.



Warning: Do not attempt to drive your scooter until you have read and understood all of the details in this user's instruction manual, failure to observe this manual may place you in a dangerous situation.

3.Manual Emergency Brake

Located on the left side of the steering handlebars. The lever when pulled towards you operates two front drum brakes. This manual braking system works independently of the main electronic braking system and must only be used in an emergency situation. For instance, if the drive transmission becomes disconnected for reasons of convenience to push you scooter.



To operate the manual brake simply squeeze the lever towards the handlebars, the harder you squeeze the more pressure will be applied to the brakes.



Warning: Remember the manual brake is connected to the front wheels only, when applied at high speed brace the handlebars to prevent your steering from wandering.

The brake lever for convenience can be locked in the "brake applied" position. To permanently lock the lever on, simply apply the brake and flick down the "locking latch" which is situated at the pivot end of the manual brake lever. To release the lever simply squeeze the "manual brake lever" and the locking latch will automatically release.



Warning: Do not drive your scooter with the manual brake applied. Failure to observe this warning will overload your scooter's drive motor and drain your batteries of power, this action could result in permanent damage to the motor, batteries and brake components.



FREEWHEELING YOUR SCOOTER

If for reasons of convenience, or you require to push your scooter for a short distance, the drive system can be put into "freewheel mode". This will allow your scooter to roll freely.

Freewheel Procedure:

The freewheel device is a red lever located at the rear right hand side of your scooter. To freewheel your scooter first switch off the power switch located on the scooter's control console. Pull up the disengage lever until a distinct click is felt. You can now push your scooter with ease.

Note: in this mode with the power switch in the off position, the braking safety system is automatically activated when the scooter is pushed quicker than walking speed, this is an automatic "run away" safety checking system, it also reduces the risk of casual theft.



Warning: When your scooter is in freewheel mode, the braking system is disengaged.

- (1) Disengage the drive motors only on a level surface.
- (2) Ensure the key is removed from the key switch.
- (3) Stand to the side of the scooter to engage or disengage freewheel mode. Never sit on a scooter to do this.
- (4) After you have finished pushing your scooter, always return it to the drive mode to lock the brakes.

Disengage



Engage





SAFETY INSTRUCTIONS & WARNING

ELECTROMAGNETIC AND RADIO FREQUENCY INTERFERENCE (EMI/RFI)

Electromagnetic and radio Frequency Interference can come from mobile phone, radio transmitters etc. In some cases, these waves can cause damage to control system. Your scooter has an immunity to EMI, the higher the immunity level, the greater the protection against EMI. Your scooter has been tested and passed at the immunity level of 20 V/M.



Warning: The addition of accessories or components to your scooter can increase the susceptibility to EMI. **Do not** modify your Scooter in any way unless authorized by Freerider.

1. Safety Check:

We recommend that you perform a safety check before each use to make certain your scooter operates smoothly and safely.

- a. Check all battery connections, make certain they are serviceable and not corroded.
- b. Check front basket is fitted correctly.
- c. Check batteries have been fully charged.
- d. Check operation of brakes.



Warning: **Do not** carry passengers on your scooter. Your scooter is designed for a single occupant which complies with legal requirements for pavement vehicles. Carrying passengers on your scooter may result in personal injury and/or property damage.

We will not be held responsible for injuries and / or property damage resulting from failure to observe these weight limitations. Please also remember when carrying heavy objects that this will increase your total weight and may make your scooter unstable.

2. Inclines:

Most modern buildings are designed with disability access in mind.

Ramps have specified percentage of inclination, designed for easy and safe access. Some ramps may have turning switchbacks (180 degrees turns) that require you to have good cornering skills on your scooter.

- a. Take a wide arc with your scooter's front wheel around tight corners, your rear wheels will follow preventing you from cutting the corner short and bumping or getting hung up on raised curbs.
- b. When descending an incline keep your speed adjustment set to the slowest speed setting to ensure a safely controlled descent and driving in a forward direction only. If your scooter descent is quicker than you anticipated allow the scooter to completely stop, then progress at a slower speed setting.



Warning: Never drive down an incline at full speed. When climbing an incline, try to keep your scooter moving, if you must stop, start up again slowly and then accelerate smoothly with caution. Avoid sudden stop starts, lean forward towards your handlebars to increase stability and prevent rearward tipping.



Warning: When climbing an incline, do not zig-zag or drive at an angle up the face of the incline. Drive your scooter smoothly up the incline without stopping, this greatly reduces the possibility of a tip or fall.

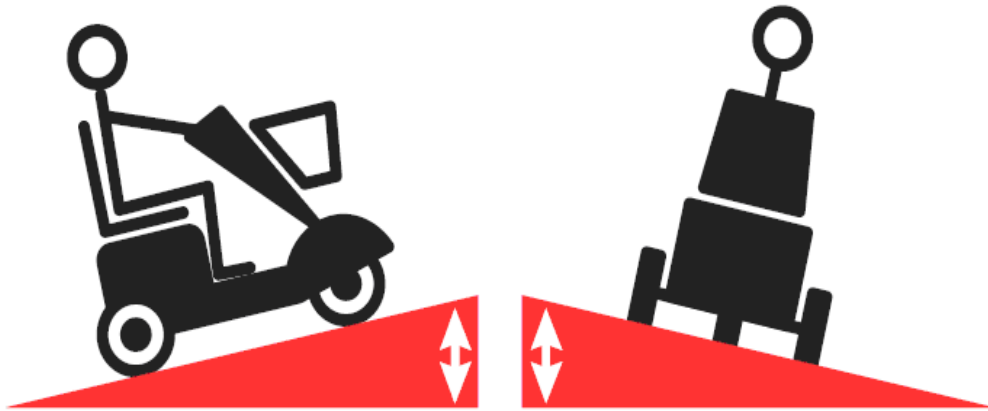

8 degrees maximum incline

8 degrees maximum incline

SAFETY WARNING & INSTRUCTION LABELS

The following labels are positioned on your scooter; they communicate important warnings or instructions regarding the safe operation of your scooter. Please familiarize yourself with their location.

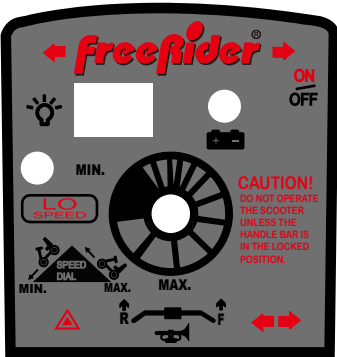

Control console label



Located in right of handlebar cover



Located on the top of the Scooter's rear cover (under seat)

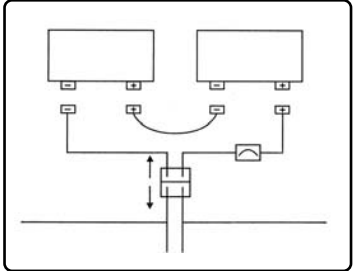

Wiring diagram for batteries located under rear cover



Data serial plate located on front wheel cross member

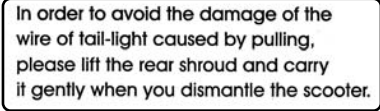

Yellow label located on the top of the rear cover



Located on the top leftside of the rear cover (under seat)



Located at right rear of handlebars near charging socket



Located at the left side of top



Located at the left or right hand rear cover of Scooter



LEARNING TO GET ABOUT

1. Basic Driving:

Make certain you are comfortably seated on your scooter and both armrests are down. Ensure that the "Speed Adjustment Dial" is turned to minimum for your first drive. When you have become more confident you can increase the setting to a higher speed. Push the right "Thumb Lever Control" as described earlier. You will very gently move forwards. Release the lever, and you will gently stop. Practice these two basic functions until you get used to them. Steering the scooter is easy by turning the handlebars in the direction you wish to maneuver.

2. Incline Control :

When you approach an incline, it is best to lean forward. This moves the center of gravity of your scooter towards the front of the scooter for improved stability. When going down an incline, keep your speed slow. This will keep you in a safely controlled descent. It is best to lean backwards; this moves the centre of gravity of your scooter towards the rear of the scooter for improved stability. If you wish to stop completely, release the control lever, and you will come to a gentle stop, avoid sudden stop starts.

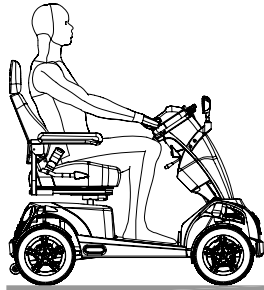

Normal driving position

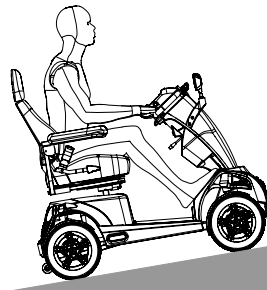

Increased Stability driving position

3. Control Over Stationary Obstacles

Stationery obstacle (steps, curbs etc.) must be avoided where possible. Proceed with extreme caution when driving near raise surfaces, unprotected ledges and / or drop offs such as curbs, porches, stairs etc.

Most new pavements have lowered curbs to transfer from the road to the pavement, use these at all times. Plan your route where possible to avoid poor and uneven surfaces. **Do not** attempt to ride up or down full curbs as you may ground your Scooter and damage its construction.

CURB

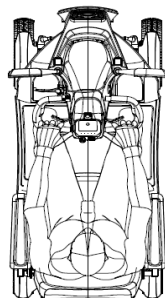

Correct

CURB

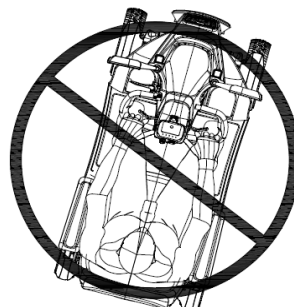

Incorrect

4. Control Over Grass, Gravel, ETC...

Care must be taken when attempting to drive over soft surfaces such as those found in parks etc. The surface may look level, but this can be deceiving and hidden dangers may make your scooter become unstable or grounded. Avoid unkempt grass, loose deep gravel or sand; **do not** exceed the capabilities of your scooter. Always have an attendant to assist you in circumstances where you are not certain of the terrain. Always plan your journey and think safety.



Caution: Because of the power of your scooter, you will be able to climb inclines. But the maximum safe gradient limit is 6 degrees. The reason for this is to ensure good stability.

Always have the anti-tipping wheels fitted to your Scooter. They are an important part of your Scooters design and significantly reduce the risk of backward tipping.

Always avoid where possible turning on slopes or climbing curbs. Always make certain that your scooter is in full working order and your batteries are fully charged before attempting to drive. Never attempt to drive beyond the design capability of your scooter. Observe weather conditions. Tires can slip on wet or icy surfaces.

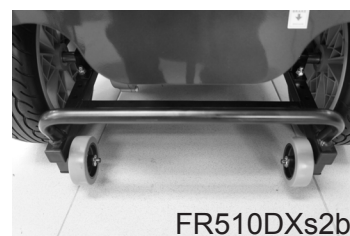

DO NOT DRIVE THROUGH WATER OR LEAVE YOUR FREERIDER EXPOSED TO HEAVY RAIN"

i.e. During or after a thunderstorm.

Do not attempt to turn when negotiating an incline, only turn when all wheels are fully on or off the incline; failure to observe this warning could result in the machine becoming unstable and toppling over. Always lean forward when ascending an incline and backwards when descending an incline. This will enable you to maintain good stability and will eliminate any chance of a rear or forward unbalance.

PLEASE NOTE: The rear stability of your scooter is dependent on a number of factors which you should consider before attempting to climb an incline or other obstacle:

- (a) Your height;
- (b) The height of your seat;
- (c) Your weight;
- (d) The angle of the incline you are attempting to climb.

All of these factors can affect the rear stability of your scooter. If you are unsure of your capability to climb an obstacle, then try another route.

Always think "safety first".



CARE & MAINTENANCE

Your scooter like any other electro-mechanical machine will benefit from regular servicing by your Freerider dealer. You too, can help keep your scooter in tip-top condition by following a simple guide to home maintenance.

Note: Only Freerider approved dealers should carry out service work.

SEAT UPHOLSTERY

A damp cloth and a little soapy water will keep your seat, backrest and arms clean. **Do not** use abrasive cleaners as this will damage the coating. Upholstery can be damaged by chemical cleaners. The coating material can also degrade over a period of time due to contamination by natural oils in the hair and skin or from medicated power products. Ultra-violet light can also reduce the life of the upholstery coating material. This is a normal ageing process and cannot be guaranteed.

BODYWORK

The painted bodywork on your scooter can be lightly washed with clean soapy water. **Do not** use abrasive cleaners or strong detergents. This could fade the colour; an auto type shampoo works well. Remove salt contact as this is very corrosive to bright metal parts.



Caution: Do not hose down your scooter with a powerful cleaner. Water could be forced into the electronics and cause permanent damage. On the painted finish, be cautious not to wash with a dirty cloth as this could scratch the paint finish. Auto polish can be used to keep the paintwork and bright chrome parts in pristine condition.

The metal framework of your scooter should be cleaned twice a year and any paintwork damaged should be treated to prevent further damage. Wash regularly if contact is made with road or sea salt, this is very corrosive.

Do not store your Scooter in damp conditions. This may affect the electronics if left for very long periods of time. Moisture, if left unattended can cause deterioration on metal work, protect with proprietary cleaners.

ELECTRONICS

Servicing of the drive electronics and charger should only be carried out by your local service dealer. These units are sealed and should not be opened.

BROKEN SEALS WILL INVALIDATE YOUR GUARANTEE.

Do not operate your scooter in exceptional weather conditions ie. very heavy rain or wind. Cover your machine up, if it is to be left unattended and outside for a long period of time.

Do not drive through deep water with your scooter. This could damage the electronic speed controller. Sea and road salts are very corrosive and should be neutralised quickly.

MOTOR

The motor on your scooter is fitted with four long-life brushes. The brushes should be inspected for wear every 12 months or more frequently if you use your scooter daily for long periods. The brushes should be changed when they have worn down to approximately 8 mm in length.

DRIVE TRANSMISSION LUBRICATION

This unit is factory filled and will not normally need additional lubrication.

*Note: Your scooter transmission is filled with a special lubricant. **Do not** attempt to force grease into the transmission as this will contaminate the original lubrication and will invalidate your guarantee.*



Caution: Take care when handling the transmission, keep well away from clothing. It is normal to find a light film of lubrication around this part.

MOTOR BRAKES

Safety Note: For your own safety, we recommend that you check the function of your scooter brakes prior to a journey.

Motor Brake: If the motor brake is functioning correctly and the drive is engaged you will not be able to push your machine when it is switched off. Or switched on with the speed control lever in the "zero speed", central position.



Warning: If your machine can be pushed as described above, the motor brake could be faulty. Please do not use, contact your local Freerider dealer.

Note: Check the Freewheeling Instructions of this manual.

DRIVING BRAKE



Warning: When you drive your scooter and you let go of the speed control lever your scooter should reduce speed very quickly. If you notice a change in the normal slowing/braking condition of your scooter and it does not slow down quickly, please **do not** use your machine, and contact your distributor.

TYRES

Check the condition of your tyres regularly. Look for signs of wear, cuts and foreign objects lodged in the tread. Maintain the tyre pressures at all times; failure to comply with this can lead to poor performance of your machine and could make your machine unsafe and/or unstable. Tyres should be replaced when the tread is worn to 0.5mm.





BATTERIES & BATTERY CHARGING

1. Battery Installation:

Your scooter is equipped with two maintenance free 12 volt 50Ah batteries. The batteries are linked together by wiring cables to supply the electronic system with 24 volts of power.



Warning: It is imperative that the two batteries are connected correctly to prevent a short circuit between the two batteries. When first installing the batteries follow these assembly instructions.

- (1) Connect the labeled positive (+) wire to the positive (+) terminal of the battery, with the screw, nut and washer provided.
- (2) Connect the labeled negative (-) wire to the negative (-) terminal of the battery, with the screw, nut and washer provided.
- (3) Repeat this procedure on the second battery making certain the plastic red/black terminal covers are secured over each terminal.
- (4) Sit on the seat and switch on your scooter, the battery meter will now move to show the state of charge in the batteries and your scooter is ready to drive.

Batteries circuit diagram

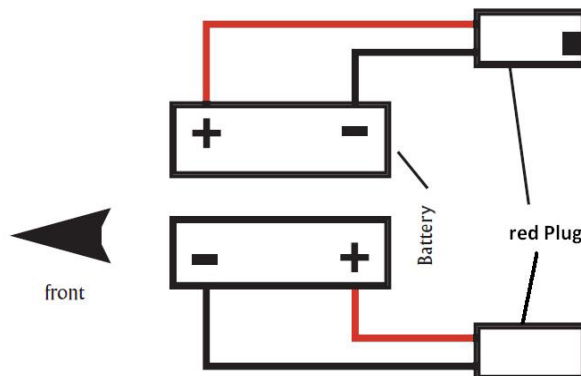

2. Battery Charging:

Your scooter has a lot of power. To ensure it works to its full potential you must maintain both batteries on full charge. Nightly recharging, after use, will help you to give them a longer life and will ensure your scooter is always ready to go when you are. Only use the charger supplied with your scooter; other makes of charger may permanently damage your batteries and would invalidate the guarantee.





BASIC FAULT FINDING

If your scooter will not start:

- (1) Check the power key switch is turned "on". If it is, the battery condition indicator meter will be operating. If the green status light on your console is flashing once per second, charge your batteries.

If the battery condition meter and the green status light fail to operate when the key switch is in the 'on' position, check the following:

- (2) Make sure the battery charger is not plugged into the tiller charge socket, this will prevent drive.
- (3) Check both battery connectors. Check battery terminal condition.
- (4) Check the "circuit breaker".

If your scooter stops for no apparent reason, it is probably due to the circuit breaker disconnecting from the speed control electronic box.

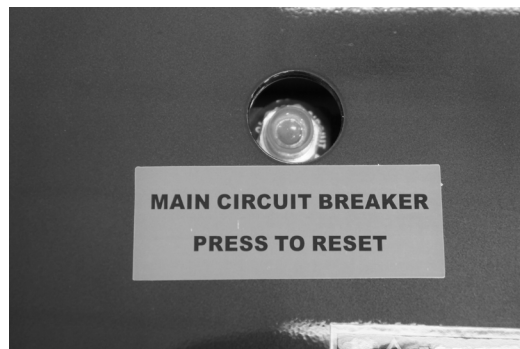

On rare occasions, a temporary overload on the electric circuit can occur – for instance when climbing a steep incline. If this happens, reset the circuit breaker, wait for two minutes to allow the temperature activated switch to cool down. Locate the plunger on the circuit breaker through the access hole. Place a finger onto the circuit breaker and press down on the plunger until it remains down. You are now ready to drive again" If the circuit breaker trips up again wait for 5 minutes and try again"

1.Fault Diagnosis:

Faults with the main speed controller are rare. Most faults on mobility scooters are associated with wiring or misconnections due to poor maintenance. If your scooter should fail to operate, you will be assisted in diagnosis and locating the area of the fault by observing the number of flashes emitted from the "green" status light on your control console.

2.Charging Circuit Fuse:

One fuse protects your scooter charging circuit from receiving an overload of electrical current. The fuse used in the scooter is the same type which is found in cars. In the unlikely event that a fuse should 'blow' and needs replacing, use only a fuse of a 10 amp rating. Please note this size of fuse has been selected to give your scooter the best protection without premature fusing.



Warning: Do not use fuses with a higher rating than 10 amps as this may cause permanent failure to the wiring and wiring connectors. For access to a fuse remove the four screws located in the rear body cover, lift cover.

Locate and lift the fuse block on it's wire, lift up the fuse lid and withdraw the "red" fuse. Replace the blown fuse with recommended 10 amp (pink) fuse, close fuse lid and replace fuse block.

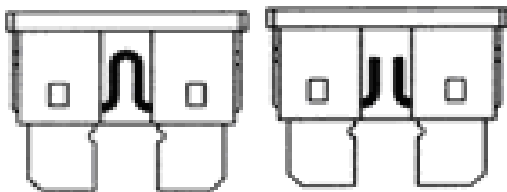
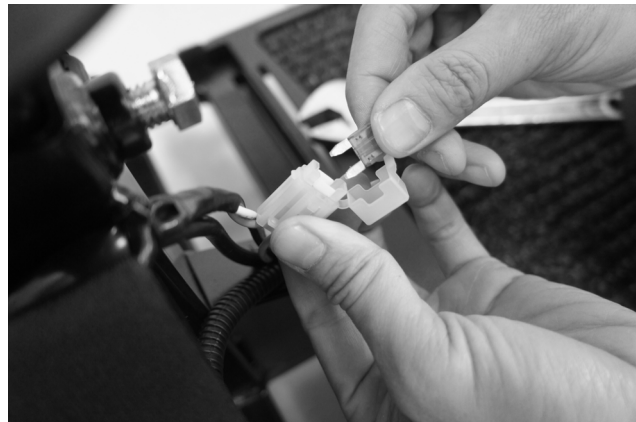
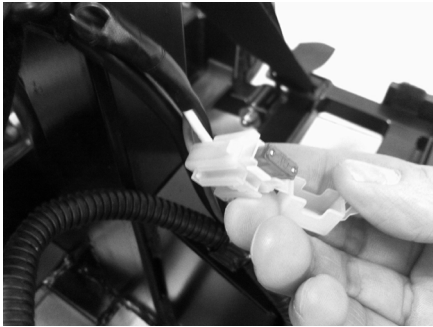

3. Status Fault Codes:

Flash	Description	Meaning
1	Battery Low	The batteries are running low. Recharge the batteries
2	Low Battery Fault	The batteries have run out of charge. Recharge the batteries. Check the battery and associated connections and wiring.
<p><i>Note:</i> <i>The low battery fault flash code, described above, is a requirement of various safety standards. The scooter will output a visible and audible low battery warning if the battery voltage drops below 90% of its cut-off voltage. The warning will be two short flashes, and will take priority over all other flash codes in the system.</i></p>		
3	High Battery Fault	Battery voltage is too high. This may occur if overcharged and / or travelling down a long slope. If travelling down a slope, reduce your speed to minimise the amount of regenerative charging.
4	Current Limit Time-out or Controller too hot	The motor has been exceeding its maximum current rating for too long. The scooter may have stalled. Turn the controller off, leave for a few minutes and turn back on again. The motor may be faulty. Check the motor and associated connections and wiring.
5	Park Brake Fault	Either a park brake release switch is active or the park brake is faulty. Check the park brake and associated connections and wiring. Ensure any associated switches are in their correct positions.
6	Drive Inhibit	Either a stop function is active, a charger Inhibit or OONAPU (Out Of Neutral At Power Up) condition has occurred. Release the stop condition (seat raised etc.) Disconnect the battery charger Ensure the throttle is in neutral when turning the controller on. The throttle may require re-calibration.
7	Speed pot Fault	The throttle, speed limit pot, or their associated wiring may be faulty. Check the throttle pot, speed pot and associated connections and wiring.
8	Motor Voltage Fault	The motor or its associated wiring is faulty. Check the motor and associated connections and wiring.
9	Other error	The controller may have an internal fault. Check the motor and associated connections and wiring.



TECHNICAL SPECIFICATION

Model Number	FR510DXs2b
Maximum Safe Slope	6 degrees
Maximum Climbing Ability	8 degrees
Maximum Obstacle Climbing Ability	2.3 inches (6 cm)
Colours	Red / Blue
Overall Length* ²	55 inches (139 cm)
Overall Width* ²	25 inches (63 cm)
Total Weight with Batteries	240 lbs. (109.1 kg)
Front Axle Weight	75.44 lbs. (34.3 kg)
Rear Axle Weight	164.56 lbs. (74.8 kg)
Total Weight Without Batteries	171.8 lbs. (78.1 kg)
Battery Weight 50Ah(Each)* ⁴	34.1 lbs. (15.5 kg)
Turning Radius	64.9 inches (165 cm)
Reversing width-tiller steering	46 inches (116 cm)
Speed (Maximum)* ¹	8 miles / hr. (12.8 kph)
Range Per Charge* ^{1*5}	35 miles (56 km)
Ground Clearance	4.5 inches (11.5 cm)
Weight Capacity	25 st (160 kg)
Standard Seating	Type: Foldable Weight (w/armrests): 37.4 lbs. (17 kg) Material: Grey Vinyl Dimensions:17 inches (47 cm) depth & width
Drive System	Rear-wheel drive, sealed transaxle,24 volt DC motor
Suspension	Rear shock absorber
Dual Braking System	Electronic, regenerative, and electromechanical
Tyres	Type: Pneumatic Front and rear: 13 inches (33 cm)
Battery Requirements* ³	Type: 12 volt, deep cycle, AGM or Gel-cell Size: 50 AH QTY: 2
Battery Charger	5-amp charger

Please view the " * " mark at page 31.

1. Varies with user weight, terrain type, battery amp-hour (AH), battery charge, battery condition and tyre condition.
These specifications can be subject to a variance of (+/- 10%).
2. Due to manufacturing tolerances and continual product improvement, this specification can be subject to a variance of (+ or - 3%).
3. AGM or gel cell type required.
4. Battery weight may vary based on manufacturer.
5. Tested in accordance with ANSI/RESNA, WC Vol2, section 4 & ISO 7176-4 standards. Results derived from theoretical calculations based on battery specifications and drive system performance.

NOTE: All specifications subject to change without notice.

The information contained herein is correct at the time of publication; we reserve the right to alter specifications without prior notice. Speed & range vary with user weight, terrain type, battery charge, battery condition and tyre pressure. Due to manufacturing tolerances and continual product improvement, length, width, turning radius and ground clearance can be subject to variance of + or – 3 %.

Features

- **Delta tiller with wraparound handles**
- **Exclusive stylish, lightweight, non-scuffing, black, low-profile wheels**
- **Easy access tiller-mounted charger port**

Options

- **Combined Basket, Stick/Crutch holder**
- **Stick/Umbrella holder**
- **Oxygen tank holder**
- **Saddle (SEAT) bag**

FR510DXs2b

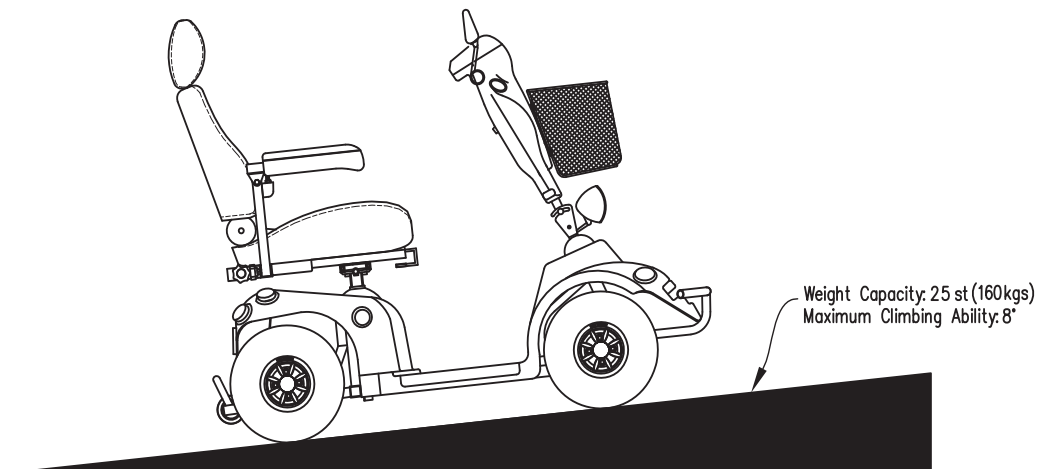
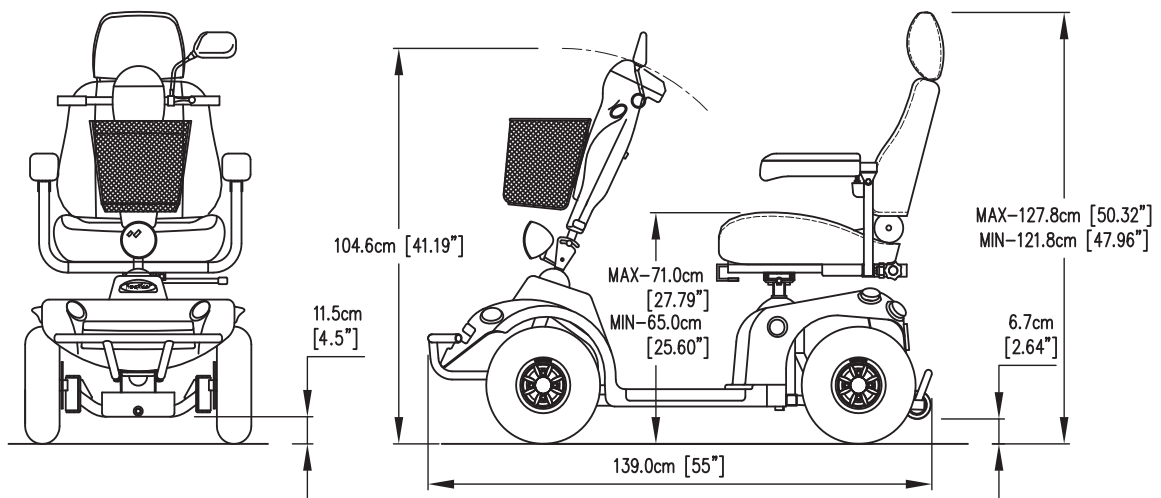
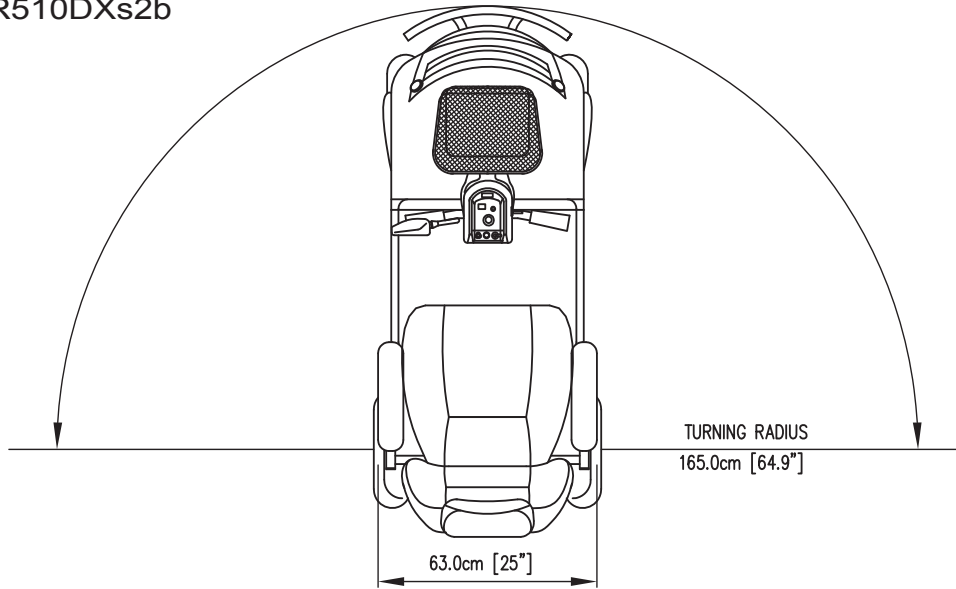



CLASSIFICATION

Class "C" indoor / with some outdoor capabilities (EN12184:1999) Class 3 (Highway Regulations 1988).

Maximum safe climbing angle: 8 degrees



Warning: The safe climbing angle is measured with the seat in the highest position, and maximum weight capacity. The motor on your scooter is powerful and may be able to climb a steeper incline than the maximum safe climbing angle. Exceeding the safe climbing angle may put you at risk of injury. On no account must you attempt to climb an incline of more than 8 degrees. This will exceed the rear stability of your scooter.

Range Per Charge: 35 miles (56 km)

Note: Range varies with weight, terrain, temperature, battery condition etc. and is subject to manufacturing tolerances. Your battery will require a period of "breaking in" before they will reach their optimum capacity (up to 20 charge, discharge cycles can be expected) before full range is experienced. Refer to the battery charging section of this manual.

Tire Size: Front & Rear 13 inches (33 cm), Pneumatic

Batteries: Lead Acid battery 50Ah

Charger: AC input. 100-240 volt, 50/60Hz,
DC output 24 volt. 5 Amp for Lead Acid battery
Conforms to: EN60335-2-29 and EN12184
EN12184:1999 (Clause 9.8)
EN55022:2010, Class B
IEC61000-4-2/ IEC61000-4-3

EMI/RFI: Field strength tested to 20 V/m compliance.

Electrical System: 24 volt DC

Drive System: Rear wheel, direct drive via sealed drive axle.

Motor: 24 volt DC. Permanent magnet totally enclosed for outdoor use.



OPTIONAL ACCESSORIES

For information regarding these optional accessories please contact your Authorised Freerider Agent.

Combined Basket, Stick / Crutch Holder

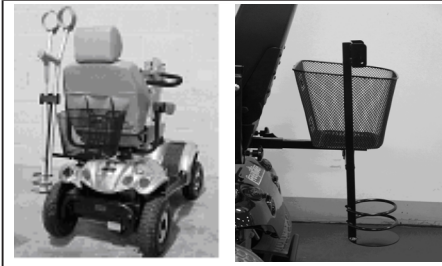

Combining the usefulness of the rear basket and the stick / crutch holder.

Stick / Umbrella Holder



Ideal way to carry walking aids.

Saddle (SEAT) Bag



Ideal way to carry your shopping and personal belongings when using your scooter.



GUARANTEE TERMS

Please keep a note of your serial No....



Your scooter is guaranteed for 12 months from the date of purchase against faults arising due to defects in manufacture or materials. This guarantee does not detract from, but is in addition to your legal rights. Parts replaced or repaired under the terms of this guarantee will be covered for the balance of the 12 months period. This guarantee applies only to parts supplied or approved by authorised dealer. This guarantee is not transferable.

Note: Extended guarantees/ insurances can be arranged by your Freerider dealer.

METAL WORK: Metal components, such as the framework and bright metal parts require special attention and may deteriorate in certain conditions. Moisture and salt may corrode parts left unattended, proprietary auto cleaner polishes should be used to prevent long term damage. Failure to clean and protect these components may void your warranty.

SPEED CONTROLLER: Servicing of the speed controller or battery charger must only be carried out by your local authorised Freerider dealer. Any attempt to open or dismantle these items render the guarantee void on that item.

BATTERIES: Batteries carry a 12 month guarantee from the original manufacturer which is subject to a stringent wear and tear clause. Any battery faults due to a defect in the original manufacture will normally become obvious within the first two months of use. Any gradual deterioration in the performance after this period is normal and associated with fair wear and tear, miss-use or accidental damage and as such is not covered by the manufacturer's warranty. (Batteries are guaranteed as single parts, only the failed part is replaceable).



Warning: Do not attempt to open the battery vent plugs.



SERVICE HISTORY

This section is designed to assist you in keeping a record of any service and repairs to your scooter.

Should you decide to sell or exchange your scooter in the future this will prove most helpful. Your service agent will also benefit from a documented record and this book should accompany the scooter when service or repair work is carried out. The service agent will complete this section and return the book to you.

DETAILS OF WORK CARRIED OUT	DEALER STAMP
	DATE INITIALS

DETAILS OF WORK CARRIED OUT	DEALER STAMP
	DATE INITIALS

DETAILS OF WORK CARRIED OUT	DEALER STAMP
	DATE INITIALS

DETAILS OF WORK CARRIED OUT	DEALER STAMP
	DATE INITIALS



SERVICE HISTORY

DETAILS OF WORK CARRIED OUT	DEALER STAMP
	DATE INITIALS

DETAILS OF WORK CARRIED OUT	DEALER STAMP
	DATE INITIALS

DETAILS OF WORK CARRIED OUT	DEALER STAMP
	DATE INITIALS

DETAILS OF WORK CARRIED OUT	DEALER STAMP
	DATE INITIALS



SERVICE HISTORY

DETAILS OF WORK CARRIED OUT	DEALER STAMP
	DATE INITIALS

DETAILS OF WORK CARRIED OUT	DEALER STAMP
	DATE INITIALS

DETAILS OF WORK CARRIED OUT	DEALER STAMP
	DATE INITIALS

DETAILS OF WORK CARRIED OUT	DEALER STAMP
	DATE INITIALS

YOUR LOCAL DEALER

freerider®

FREERIDER CORP.

Head Quarter and Kaohsiung Facility:
No.22, Bengong 5th Rd., Gangshan Dist.,
Kaohsiung City 820, Taiwan(R.O.C)
Tel:886-7-6223093 Fax:886-7-6230373
Email: sales @ freerider.com.tw
<http://www.freerider.com.tw>
<http://www.luggie.com.tw>

2014.06.25 V2



PL90-1700